

RoHS Compliant

更改 REV	设计内容 MODIFICATION	日期 DATE	制图 DRAW	核准 APPROVE
A	图面发行	2012/10/29	LINYUN	ZHANG

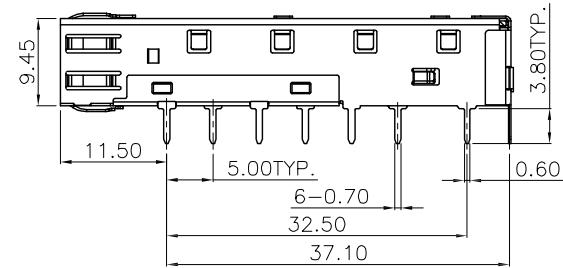
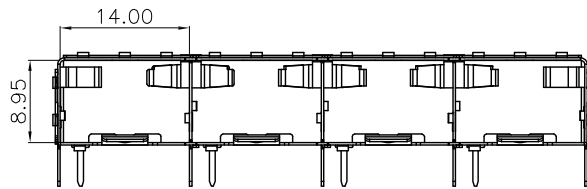
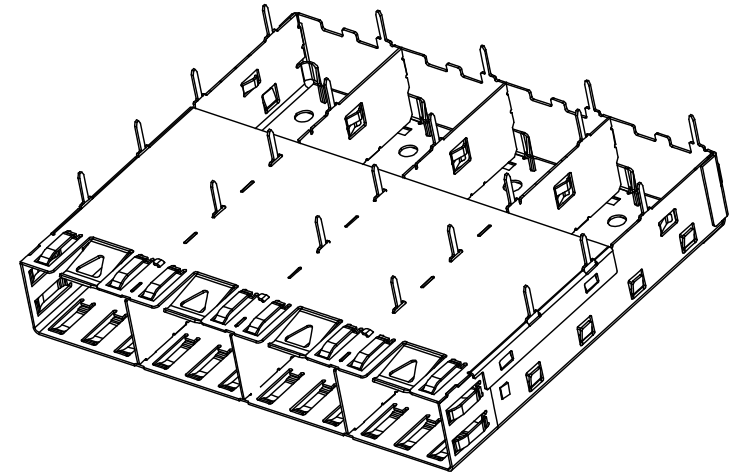
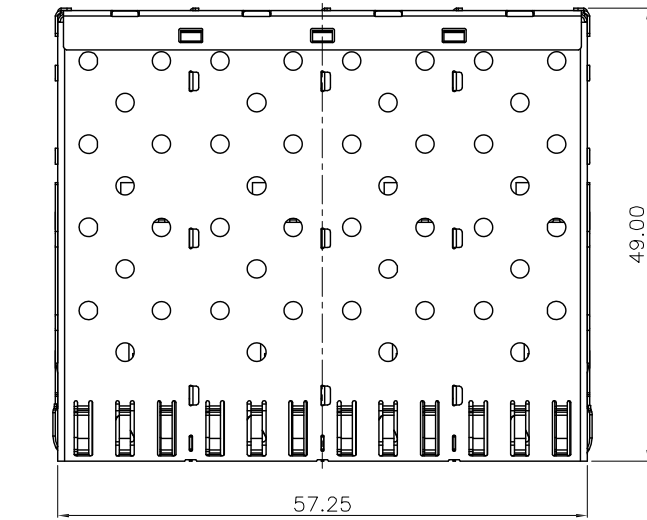

NOTES:
 MECHANICAL:
 CAGES: COPPER ALLOY, THICKNESS 0.25MM.
 PLATING: NO NEED.
 THIS CAGE IS FOR SINGLE SIDE USE ONLY.
 TEMPERATURE:
 OPERATION: -40°C~+85°C
 STORAGE: -40°C~+85°C
 RoHS COMPLIANCE.

HTTPS://WWW.CHNCONN.COM		深圳市创勤电子有限公司 SHENZHEN CHUANGQIN ELECTRONICS CO., LTD.	
◎ : Inspection Item ◎ : Cp/Cpk and SPC Control Item	DIMENSION IN mm [Inch]		图号 DWG NO.
	TOLERANCE UNLESS OTHERWISE SPECIFIED		料号 PART NO.
	.X± 0.25	X.°± 1°	SFP-1X4-GZ
	.XX± 0.20	.X.°± 0.5°	CQ047-SFP-1X4-L0-D
.XXX± 0.15		名称 TITLE	
核准 APPROVE		审核 CHECK	制图 DRAW
ZHANG		LIJY	LINYUN
角法 PROJ.		比例 SCALE	图号 SHEET
1:1		1 / 1	图号 SIZE
A3		更改 REV	A

RoHS Compliant

更改 REV	设计内容 MODIFICATION	日期 DATE	制图 DRAW	核准 APPROVE
A	图面发行	2012/10/29	LINYUN	ZHANG

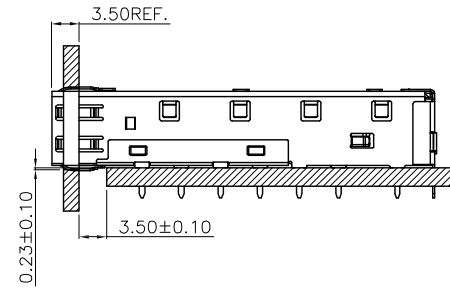
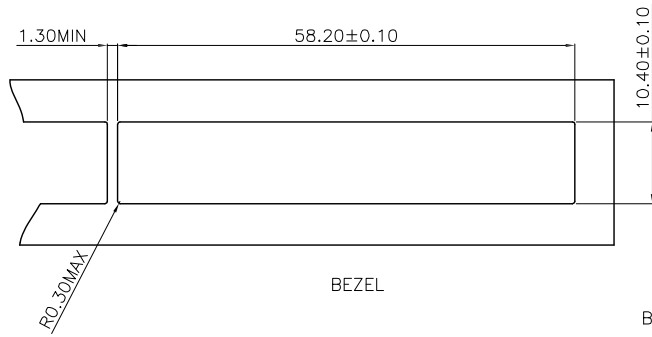

BEZEL OPENING
BELOW TOP OF PCB

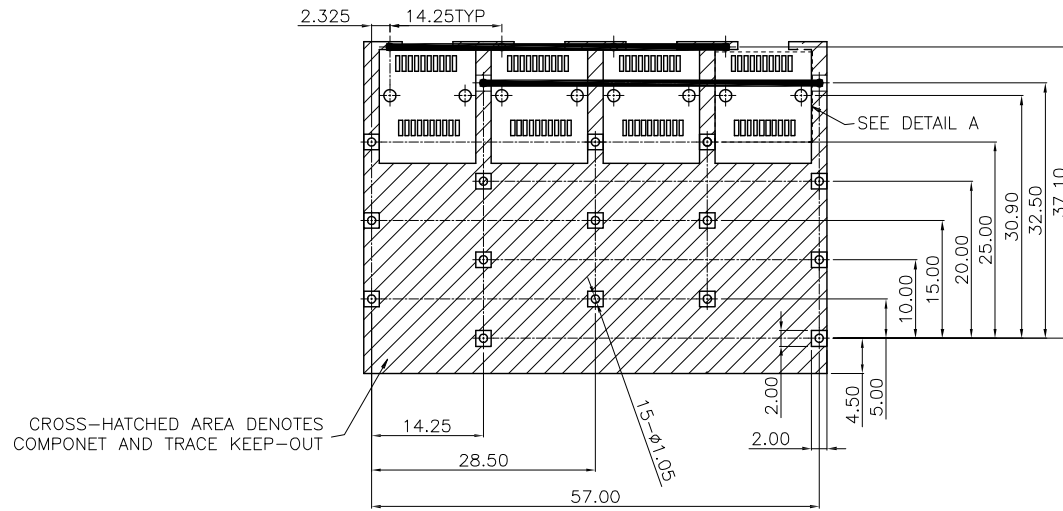

CROSS-HATCHED AREA DENOTES
COMPONENT AND TRACE KEEP-OUT

EDGE OF BOARD

RECOMMENDED PCB LAYOUT (COMPONENT SIDE)
PCB TOLERANCE: ±0.05

“□” “■” “●” “○” 圆孔均为通孔

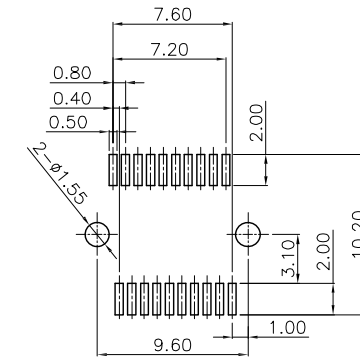

DETAIL A(SCALE 2:1)

HTTPS://WWW.CHNCONN.COM		深圳市创勤电子有限公司 SHENZHEN CHUANGQIN ELECTRONICS CO., LTD.	
Inspection Item Cp/Cpk and SPC Control Item	DIMENSION IN mm [Inch]		图号 DWG NO.
	TOLERANCE UNLESS OTHERWISE SPECIFIED		料号 PART NO.
	.X± 0.25	X.*± 1°	SFP-1X4-GZ
	.XX± 0.20	.X.*± 0.5°	CQ047-SFP-1X4-L0-D
.XXX± 0.15		名称 TITLE	
核准 APPROVE		审核 CHECK	
ZHANG		LIJY	
制图 DRAW		制法 PROJ.	
LINYUN		图号 SHEET	
比例 SCALE		更改 REV	
1:1		1 / 1	
图纸 SIZE		A3	
A		A	