

SECTION A-A

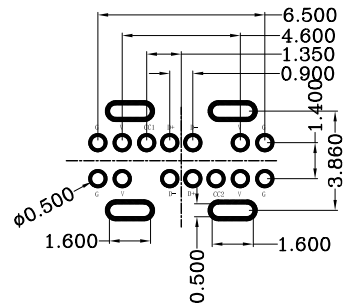

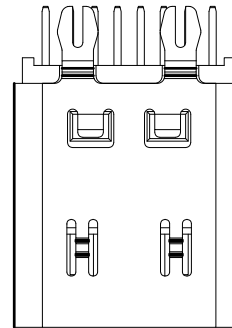
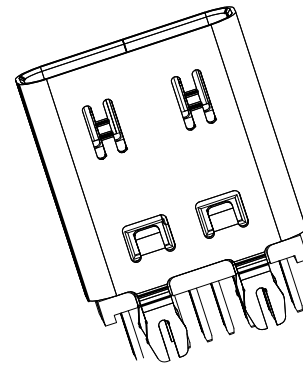
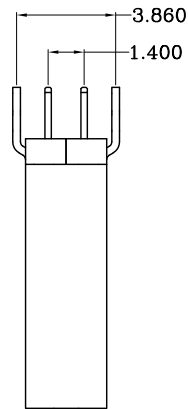
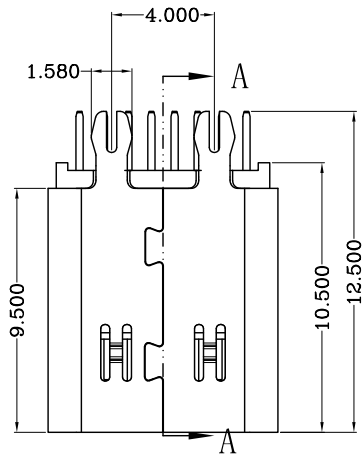
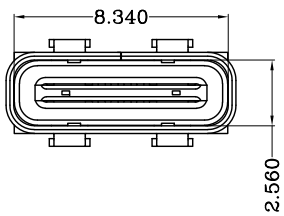
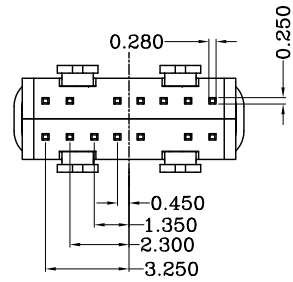

RECOMMENDED P.C.B. LAYOUT
TOLERANCE UNSPECIFIED ±0.05mm

TYPE C USB技术要求:

1. 电气性能
 - 1.1. 额定电流 3A
 - 1.2. 额定电压: 5V.
 - 1.3. 接触阻抗: 40mΩ Max.
可靠性和环境测试后阻抗变化不得超过10mΩ.
 - 1.4. 绝缘阻抗: 100 MΩMin.
2. 机械性能
 - 2.1. 插入力: 5-20N. 拔出力: 6-20N.
 - 2.2. 寿命测试 5000 Max.
 - 2.3. 推力: 50N min.
 - 2.4. 剥离强度: 150N min.
 - 2.5. 扭曲强度: 0.75Nm
3. 材料要求
 - 4.1. 胶芯材料: LCP
 - 4.2. 外壳材料: SUS304
 - 4.3. 端子材料: C2680
4. 盐雾要求: 24H
5. 工作温度: -20° C~85° C

A1	GND	B12	GND
A4	VBUS	B9	VBUS
A5	CC1	B8	SBU2
A6	DP1	B7	DN2
A7	DM1	B6	DP2
A8	SBU1	B5	CC2
A9	VBUS	B4	VBUS
A12	GND	B1	GND
PIN	SIGNAL NAME	PIN	SIGNAL NAME

REV	DESCRIPTION	ECN.NO	DATE
-----	-------------	--------	------

-TOLERANCES- UNLESS OTHERWISE SPECIFIED 公差参考表		深圳市创勤电子有限公司 SHENZHEN CHUANGQIN ELECTRONICS CO., LTD.			
		 		TITLE: Type C 母座 14PIN 产品名稱: 立插 H=10.5	
X.X ±0.30	X.X* ±5°	APPD: ZHANG 核准:	DWG NO: CQ087-TFLC1410501 产品料號:		
X.XX ±0.20	X.XX* ±2°	CHECK: LIJY 校對:	DATE	SCALE	UNIT
X.XXX ±0.10	X.XXX* ±1°	DRAW: LINYUN 繪圖:	20210308	1:1	mm
			PAGE	1/1	